

# 10Gbps SFP+ Optical Transceiver, 80km Reach

## SFP+-10GB-ZR

### Features

- 1550nm cooled EML Transmitter
- High sensitivity APD Receiver
- Distance up to 80km over SMF
- Single 3.3V Power supply and TTL Logic Interface
- Duplex LC Connector Interface
- Hot Pluggable
- Power Dissipation < 1.5 W
- Dispersion Tolerance 1600ps/nm
- Operating Case Temperature Standard : 0°C to +70°C
- Compliant with SFF-8431 MSA
- Compliant with SFF-8432 MSA
- Compliant with SFF-8472 MSA
- Compliant with IEEE 802.3ae

### Applications

- 10GBASE-ZR/ZW
- 10G FC
- Other optical links

### Description

The SFP+-10GB-ZR series single mode transceiver is small form factor pluggable module for duplex optical data communications up to 10G. It is with the SFP+ 20-pin connector to allow hot plug capability.

This module is designed for single mode fiber and operates at a nominal wavelength of 1550nm. The transmitter section uses a 1550nm EML, which is class 1 laser compliant according to International Safety Standard IEC-60825.

The receiver section uses an integrated InGaAs detector preamplifier (IDP) mounted in an optical header and a limiting post-amplifier IC.



## Absolute Maximum Ratings <sup>\*Note</sup>

Parameter	Symbol	Min	Max	Unit
Supply Voltage	V <sub>cc</sub>	-0.5	3.6	V
Storage Temperature	T <sub>s</sub>	-40	+85	°C

Note: Exceeding any one of these values may destroy the device permanently.

## Recommended Operating Conditions

Parameter	Symbol	Min	Typical	Max	Unit
Operating Case Temperature	T <sub>c</sub>	0		+70	°C
Power Supply Voltage	V <sub>cc</sub>	3.15	3.3	3.45	V
Power Supply Current	I <sub>cc</sub>			455	mA
Surge Current	I <sub>Surge</sub>			+30	mA
Baud Rate				10.3	Gbit/s

## Electrical Characteristics

Parameter	Symbol	Min	Typical	Max	Unit	Notes
<b>Transmitter</b>						
CML Inputs(Differential)	V <sub>in</sub>	150		1200	mVpp	AC coupled inputs
Input Impedance (Differential)	Z <sub>in</sub>	85	100	115	ohms	R <sub>in</sub> > 100 kohms @ DC
Tx_DISABLE Input Voltage – High		2		V <sub>cc</sub> +0.2	V	
Tx_DISABLE Input Voltage – Low		0		0.8	V	
Tx_FAULT Output Voltage – High		2		V <sub>cc</sub> +0.3	V	I <sub>o</sub> = 400μA; Host V <sub>cc</sub>
Tx_FAULT Output Voltage – Low		0		0.5	V	I <sub>o</sub> = -4.0Ma
<b>Receiver</b>						
CML Outputs (Differential)	V <sub>out</sub>	350		700	mVpp	AC coupled outputs
Output Impedance (Differential)	Z <sub>out</sub>	85	100	115	ohms	
Rx_LOS Output Voltage – High		2		V <sub>cc</sub> +0.3	V	I <sub>o</sub> = 400μA; Host V <sub>cc</sub>
Rx_LOS Output Voltage – Low		0		0.8	V	I <sub>o</sub> = -4.0Ma
MOD_DEF ( 2:0 )	VoH	2.5			V	With Serial ID
	VoL	0		0.5	V	

## Optical Characteristics

Parameter	Symbol	Min	Typical	Max	Unit
9µm Core Diameter SMF			80		km
<b>Transmitter</b>					
Centre Wavelength	$\lambda_c$	1528	1550	1565	nm
Spectral Width (-20dB)	$\Delta\lambda$			1	nm
Average Output Power*note1	$P_{out, AVG}$	0		4	dBm
Optical Modulation Amplitude	$P_{out, OMA}$	1			dBm
Extinction Ratio	ER	3.5			dB
Side Mode Suppression Ratio	SMSR	30			dB
Transmitter and Dispersion Penalty	TDP			3	dB
Average Power of OFF Transmitter				-30	dBm
Relative Intensity Noise	RIN			-128	dB/Hz
Input Differential Impedance	$Z_{IN}$	90	100	110	$\Omega$
TX Disable Assert Time	$t_{off}$			10	us
<b>Receiver</b>					
Centre Wavelength	$\lambda_c$	1260		1600	nm
Sensitivity*note2	$P_{min}$			-23	dBm
Receiver Overload	$P_{MAX}$	-8			dBm
Output Differential Impedance	$P_{IN}$	90	100	110	$\Omega$
LOS De-Assert	$LOS_D$			-24	dBm
LOS Assert	$LOS_A$	-36			dBm

Note1: Output is coupled into a 9/125µm SMF.

Note2: Measured with worst ER, BER less than 1E-12 and PRBS 2<sup>31</sup> -1 at 10.3Gbps.

## SFP+ Transceiver Electrical Pad Layout

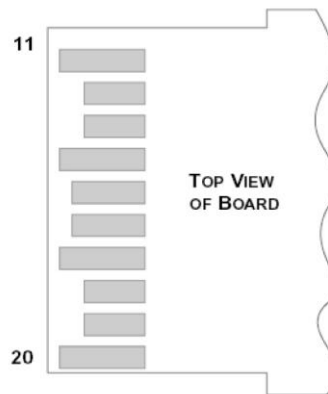
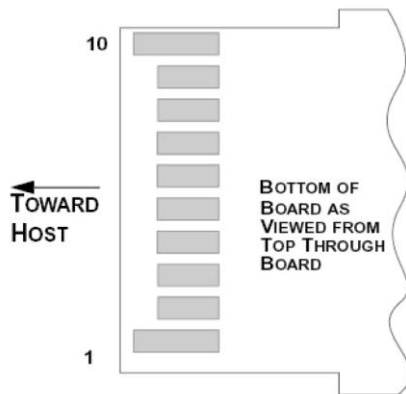
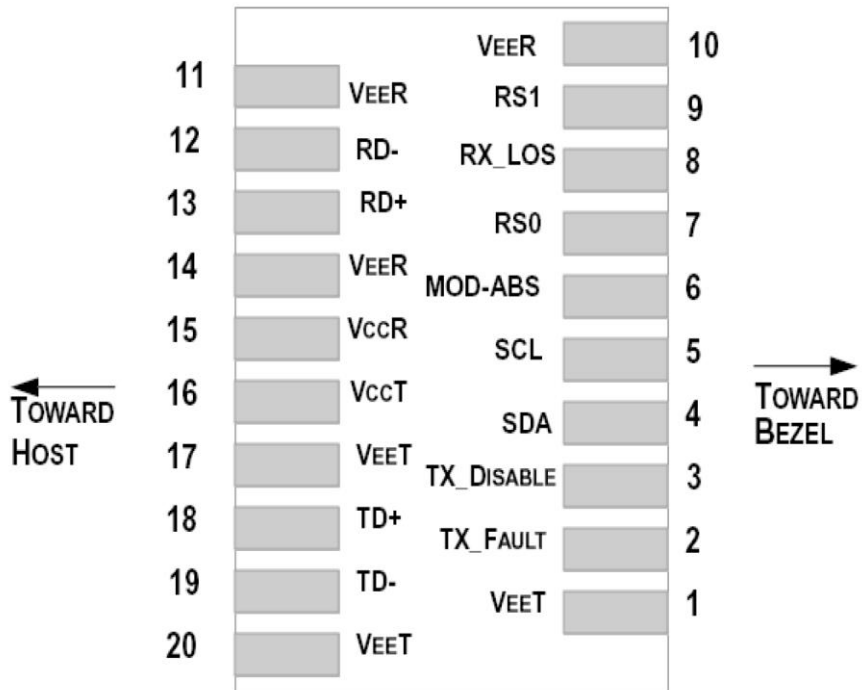

## Pin Descriptions

Pin	Signal Name	FUNCTION	Plug Seq.	Notes
1	VeeT	Transmitter Ground	1	Note 5
2	TX Fault	Transmitter Fault Indication	3	Note 1
3	TX Disable	Transmitter Disable	3	Note 2, Module disables on high or open
4	SDA	Module Definition 2	3	2-wire Serial Interface Data Line.
5	SCL	Module Definition 1	3	2-wire Serial Interface Clock.
6	MOD_ABS	Module Definition 0	3	Note 3
7	RS0	RX Rate Select (LVTTTL).	3	Rate Select 0, optionally controls SFP+ module receiver. This pin is pulled low to VeeT with a >30K resistor.
8	LOS	Loss of Signal	3	Note 4
9	RS1	TX Rate Select (LVTTTL).	1	Rate Select 1, optionally controls SFP+ module transmitter. This pin is pulled low to VeeT with a >30K resistor.
10	VeeR	Receiver ground	1	Note 5
11	VeeR	Receiver ground	1	Note 5
12	RD-	Inv. Received Data Out	3	Note 6
13	RD+	Received Data Out	3	Note 6
14	VeeR	Receiver ground	1	Note 5
15	VccR	Receiver Power Supply	2	3.3V ± 5%, Note 7
16	VccT	Transmitter Power Supply	2	3.3V ± 5%, Note 7
17	VeeT	Transmitter Ground	1	Note 5
18	TD+	Transmit Data In	3	Note 8
19	TD-	Inv. Transmit Data In	3	Note 8
20	VeeT	Transmitter Ground	1	Note 5

### Notes:

- 1) TX Fault is an open collector/drain output, which should be pulled up with a 4.7K – 10KΩ resistor on the host board. Pull up voltage between 2.0V and VccT/R+0.3V. When high, output indicates a laser fault of some kind. Low indicates normal operation. In the low state, the output will be pulled to < 0.8V.
- 2) TX disable is an input that is used to shut down the transmitter optical output. It is pulled up within the module with a 4.7K – 10 KΩ resistor. Its states are: Low (0 – 0.8V): Transmitter on (>0.8, < 2.0V): Undefined High (2.0 – 3.465V): Transmitter Disabled Open: Transmitter Disabled
- 3) Module Absent, connected to VeeT or VeeR in the module.
- 4) LOS (Loss of Signal) is an open collector/drain output, which should be pulled up with a 4.7K – 10KΩ resistor. Pull up voltage between 2.0V and VccT/R+0.3V. When high, this output indicates the received optical power is below the worst-case receiver sensitivity (as defined by the standard in use). Low indicates normal operation. In the low state, the output will be pulled to < 0.8V.
- 5) The module signal ground contacts, VeeR and VeeT, should be isolated from the module case.
- 6) RD-/+ : These are the differential receiver outputs. They are AC coupled 100Ω differential lines which should be terminated with 100Ω (differential) at the user SERDES. The AC coupling is done inside the module and is thus not required on the host board. The voltage swing on these lines will be between 350 and 700 Mv differential (175 –350 Mv single ended) when properly terminated.
- 7) VccR and VccT are the receiver and transmitter power supplies. They are defined as 3.3V ±5% at the SFP+ connector pin. Maximum supply current is 680Ma. Recommended host board power supply filtering is shown below. Inductors with DC resistance of less than 1 ohm should be used in order to maintain the required voltage at the SFP+ input pin with 3.3V supply voltage. When the recommended supply-filtering network is used, hot plugging of the SFP+ transceiver module will result in an inrush current of no more than 30Ma greater than the steady state value. VccR and VccT may be internally connected within the SFP+ transceiver module.
- 8) TD-/+ : These are the differential transmitter inputs. They are AC-coupled, differential lines with 100Ω differential termination inside the module. The AC coupling is done inside the module and is thus not required on the host board. The inputs will accept differential swings of 150 – 1200 Mv (75 – 600Mv single-ended).

## Digital Diagnostic Interface Definition

The serial interface uses the 2-wire serial CMOS EEPROM protocol defined for the ATMEL AT24C02/04 family of components. When the serial protocol is activated, the host generates the serial clock signal (SCL). The positive edge clocks data into those segments of the EEPROM that are not writing protected within the SFP+ transceiver. The negative edge clocks data from the SFP+ transceiver. The serial data signal (SDA) is bi-directional for serial data transfer. The host uses SDA in conjunction with SCL to mark the start and end of serial protocol activation. The memories are organized as a series of 8-bit data words that can be addressed individually or sequentially.

The Module provides diagnostic information about the present operating conditions. The transceiver generates this diagnostic data by digitization of internal analog signals. Calibration and alarm/warning threshold data is written during device manufacture. Received power monitoring, transmitted power monitoring, bias current monitoring, supply voltage monitoring and temperature monitoring all are implemented. If the module is defined as external calibrated, the diagnostic data are raw A/D values and must be converted to real world units using calibration constants stored in EEPROM locations 56 – 95 at wire serial bus address A2h. The digital diagnostic memory map specific data field define as following .For detail EEPROM information, please refer to the related document of SFF 8472 Rev 10.2.

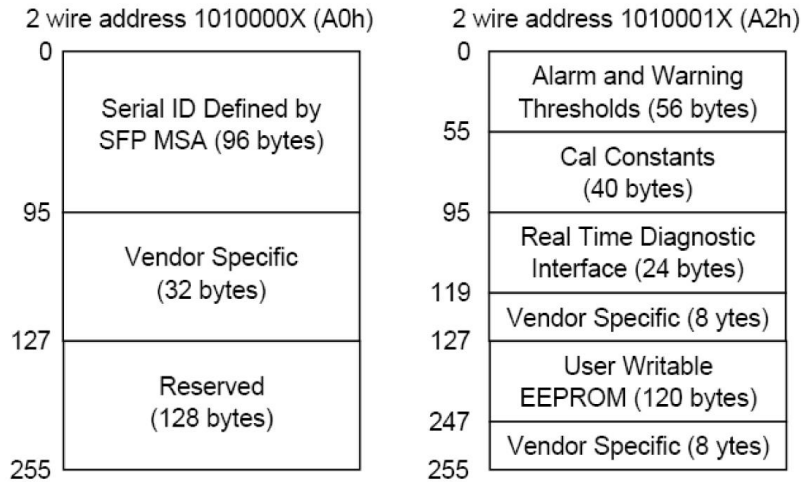

## Recommended Interface Circuit

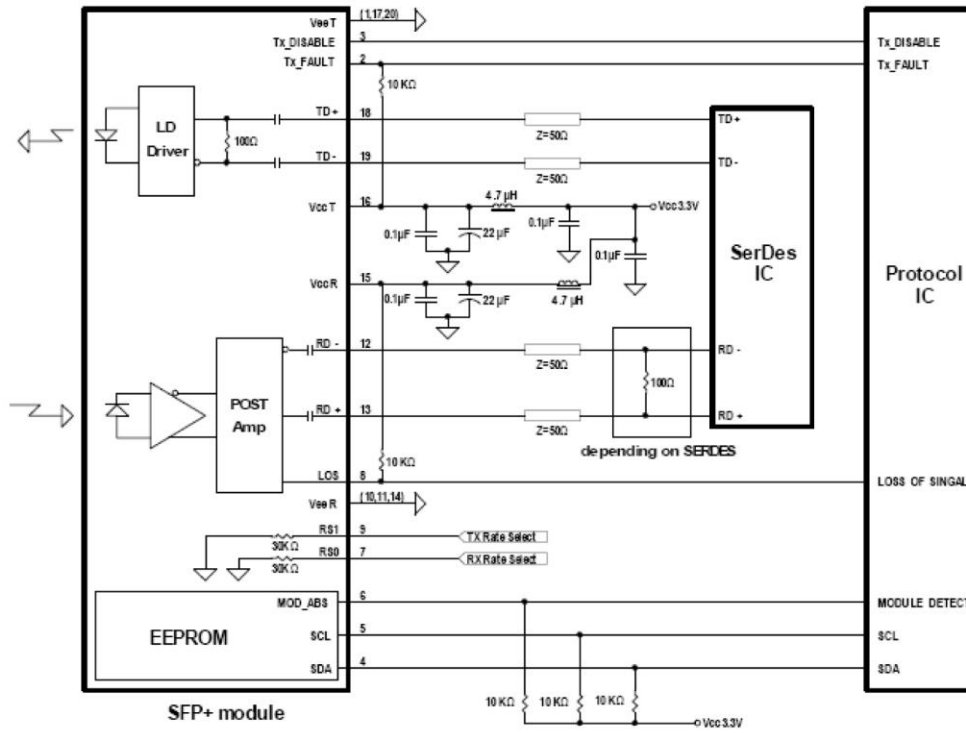

## Mechanical Dimensions

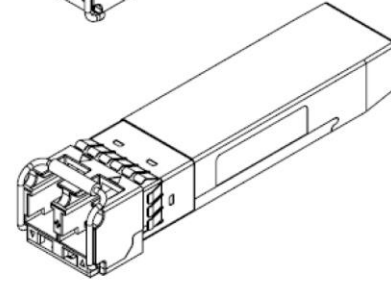
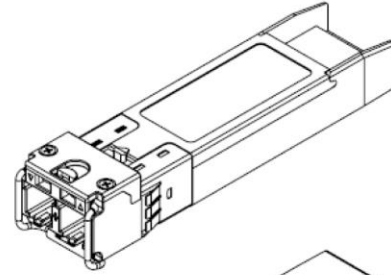
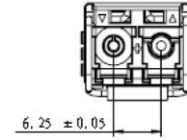
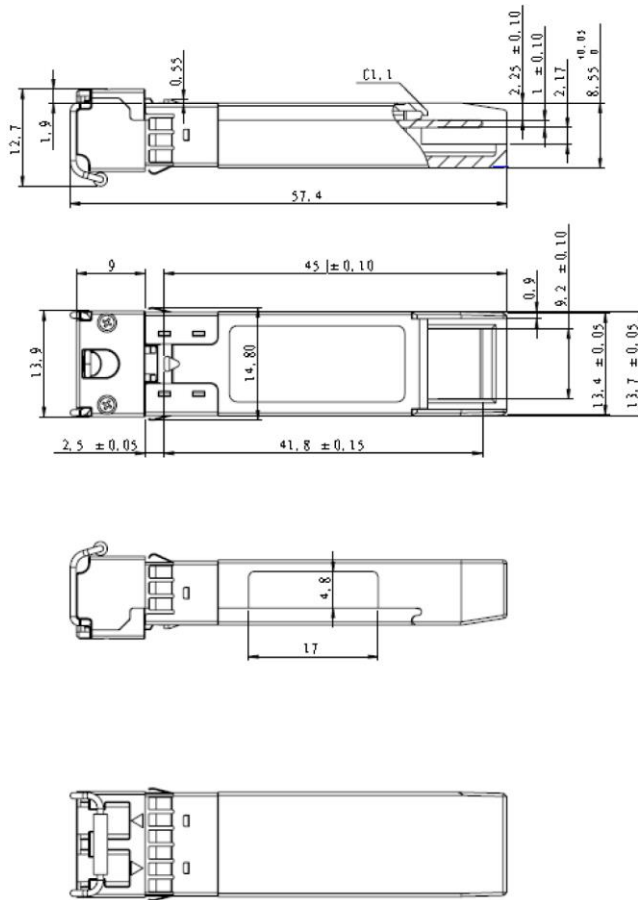

## Eye Safety

This single-mode transceiver is a Class 1 laser product. It complies with IEC-60825 and FDA 21 CFR 1040.10 and 1040.11. The transceiver must be operated within the specified temperature and voltage limits. The optical ports of the module shall be terminated with an optical connector or with a dust plug



## Regulatory Compliance

Feature	Standard	Performance
Electrostatic Discharge (ESD) to the Electrical Pins	MIL-STD-883G Method 3015.7	Class 1C (>1000 V)
Electrostatic Discharge to the enclosure	EN 55024:1998+A1+A2 IEC-61000-4-2 GR-1089-CORE	Compliant with standards
Electromagnetic Interference (EMI)	FCC Part 15 Class B EN55022:2006 CISPR 22B :2006 VCCI Class B	Compliant with standards Noise frequency range: 30 MHz to 6 GHz. Good system EMI design practice required to achieve Class B margins. System margins depend on customer host board and chassis design.
Immunity	EN 55024:1998+A1+A2 IEC 61000-4-3	Compliant with standards. 1kHz sine-wave, 80% AM, from 80 MHz to 1 GHz. No effect on transmitter/receiver performance is detectable between these limits.
Laser Eye Safety	FDA 21CFR 1040.10 and 1040.11 EN (IEC) 60825-1:2007 EN (IEC) 60825-2:2004+A1	CDRH compliant and Class I laser product. TüV Certificate No. 50135086
Component Recognition	UL and CUL EN60950-1:2006	UL file E317337 TüV Certificate No. 50135086 (CB scheme )
RoHS6	2002/95/EC 4.1&4.2 2005/747/EC 5&7&13	Compliant with standards <sup>*note</sup>

### Note:

For update of the equipments and strict control of raw materials, OPTONE has the ability to supply the customized products since Jan 1st, 2007, which meets the requirements of RoHS6 (Restrictions on use of certain Hazardous Substances) of European Union.

In light of item 5 in RoHS exemption list of RoHS Directive 2002/95/EC, Item 5: Lead in glass of cathode ray tubes, electronic components and fluorescent tubes.

In light of item 13 in RoHS exemption list of RoHS Directive 2005/747/EC, Item 13: Lead and cadmium in optical and filter glass. The three exemptions are being concerned for Optone's transceivers, because Optone's transceivers use glass, which may contain Pb, for components such as lenses, isolators, and other electronic components.

## Ordering information

Part Number	Product Description
SFP+-10GB-ZR	1550nm, 10Gbps, LC, 80km, 0°C~+70°C, With DDM

## Important Notice

Performance figures, data and any illustrative material provided in this data sheet are typical and must be specifically confirmed in writing by OPTONE before they become applicable to any particular order or contract. In accordance with the OPTONE policy of continuous improvement specifications may change without notice.

The publication of information in this data sheet does not imply freedom from patent or other protective rights of OPTONE or others. Further details are available from any OPTONE sales representative.

[sales@optone.net](mailto:sales@optone.net)

<http://www.optone.net>



Edition MAY 20, 2022  
Published by Optone Technology Limited  
Copyright © OPTONE  
All Rights Reserved